

2

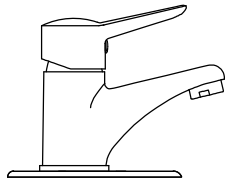

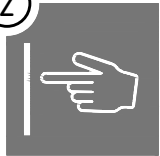

0%

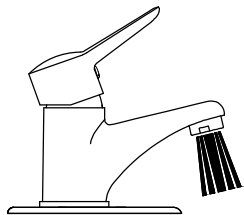
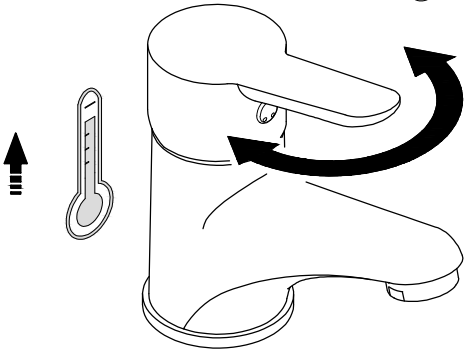
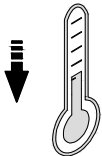



100%



 **P**  
P bar

 MAX. 10  
5

 5  

  **T**  
°C

 - 85 MAX.

 - 65  
- 45  

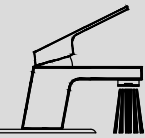
 **Q**  
(3 bar)  
l/min

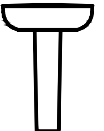
   
14

3

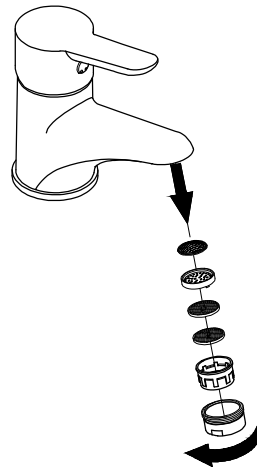

1 h

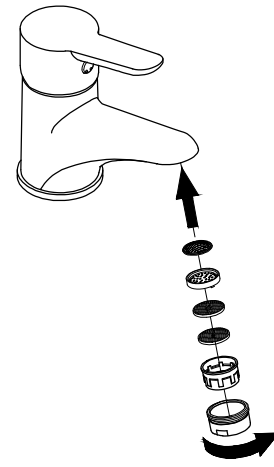

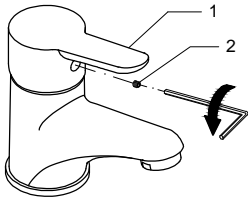
**A**  

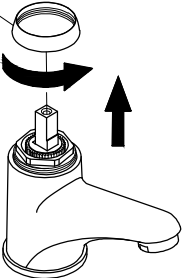
**B**  

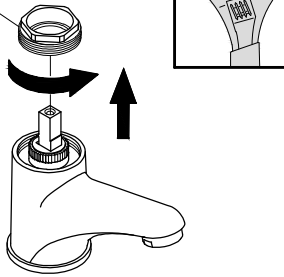
**C**  

**D**  
